

Article number: 12716000020100

Description: KLEE-coil 716 000 020.100  
M2 Unhardened

## Measures

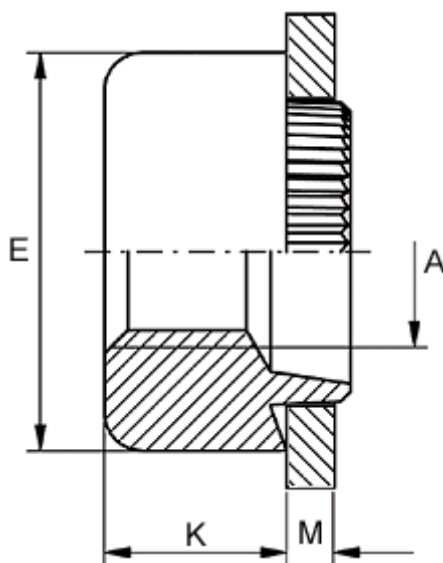

Female thread A	= M2
Height K	= 3.0
Outer diameter E	= 8.0
Plate thickness	= 4.4 to 4.6
Recommended bore diameter for extreme load	= 6.0
Recommended bore diameter for normal use	= 6.0